



# TW2 Series

## Wall Mount Temperature Sensors

### Product Overview

The TW2 Series of temperature sensors for living space is a versatile sensor platform for use with BAS controllers designed to accept 4 to 20mA, 0 to 5Vdc or 0 to 10Vdc outputs. TW2 Series sensors are available with three user interface options: touchscreen, LCD with three buttons and blank.



### NOTICE

- This product is not intended for life or safety applications.
- Do not install this product in hazardous or classified locations.
- Read and understand the instructions before installing this product.
- Turn off all power supplying equipment before working on it.
- The installer is responsible for conformance to all applicable codes.

If this product is used in a manner not specified by the manufacturer, the protection provided by the product may be impaired. No responsibility is assumed by the manufacturer for any consequences arising out of the use of this material.

### Product Identification

<b>User Interface</b>	<b>Output</b>	<b>Temperature</b>
TW2 <input type="checkbox"/>	<input type="checkbox"/>	<input type="checkbox"/>
T = Color touchscreen L = 3-button LCD display X = None	A = Analog output	A = Transmitter only C = 1000 PT RTD D = 10K T2 thermistor H = 10K T3 thermistor K = 10K curve G/11K shunt M = 20K NTC thermistor N = 1.8K TAC thermistor

### Specifications

OPERATING ENVIRONMENT	
<b>Input Power</b>	Class 2; 20 to 30 Vdc, 24 Vac, 50 to 60 Hz
<b>Analog Output</b>	Selectable 4 to 20 mA, 0 to 5 V, 0 to 10 V
<b>Operating Temp. Range</b>	0 to 50 °C (32 to 122 °F)
<b>Operating Humidity Range</b>	0 to 95% RH non-condensing
<b>Housing Material</b>	High-impact ABS plastic
<b>Terminal Block Torque</b>	0.5 to 0.6 N-m (0.37 to 0.44 in-lbf)
TEMPERATURE TRANSMITTER OPTION	
<b>Sensor Type</b>	Solid state, integrated circuit
<b>Accuracy</b>	±0.2 °C (±0.4 °F) typical
<b>Resolution</b>	0.1 °C (0.1 °F)
<b>Range</b>	0 to 50 °C (32 to 122 °F)
DISPLAY MODELS	
<b>Touchscreen</b>	61 mm (2.4 in), color, backlit, capacitive, 240x300 px Setpoint: 0-10Vdc. Temperature or fan speed selectable Timeout override: Display timeout* Lockout override: Touchscreen/button lockout*
<b>LCD</b>	52mm (2.05 in), segmented with 3 buttons Setpoint: 0-10Vdc. Temperature or fan speed selectable Timeout override: Display timeout* Lockout override: Touchscreen/button lockout*

## Specifications (cont.)

<b>SETPOINTS**</b>	
<b>Temperature Setpoint</b>	0 to 10V output Scale: 10 to 35 °C (50 to 95 °F) / 0 to 50 °C (32 to 122 °F)
<b>Fan Speed Setpoint</b>	0 to 10V output Off 0V, Low 3.3V, Med. 6.7V, High 10.0V
<b>WIRING TERMINALS</b>	
<b>Terminal Blocks</b>	Screw terminals, 18-24 AWG
<b>Screw Terminal Torque</b>	0.2 N-m (2.0 in-lbf) max.
<b>OVERRIDE</b>	
<b>Override Button</b>	Display models feature a momentary-to-ground override button
<b>WARRANTY</b>	
<b>Limited Warranty</b>	5 years
<b>COMPLIANCE INFORMATION</b>	
<b>Agency Approvals</b>	UL 916, European conformance CE: EN61000-6-2, EN61000-6-3, EN61000 Series - industrial immunity, EN 61326-1 FCC Part 15 Class B, REACH, RoHS, RCM (Australia), ICES-003 (Canada)

\*DIP switch selectable.

\*\* One setpoint type is selectable via DIP switch on display models only.

## Dimensions

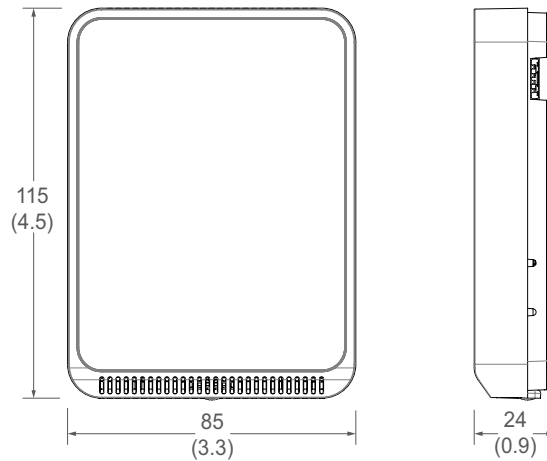

## Functions

The TW2 Series sensor measures the temperature in a room and provides analog outputs to a controller.

## Installation

1. Remove the cover from the base at the bottom of the device.



## Installation (cont.)

- Position the sensor base vertically on the wall 1.35 m (4.5 ft.) above the floor with the “UP” arrow facing upward. Locate away from windows, vents and other sources of draft. If possible, do not mount on an external wall, as this may cause inaccurate temperature readings.



- Pull 18 or 22 AWG cable(s) through the hole in the backplate.

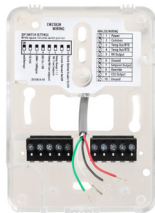

- Mount the backplate onto the wall using the screws provided.

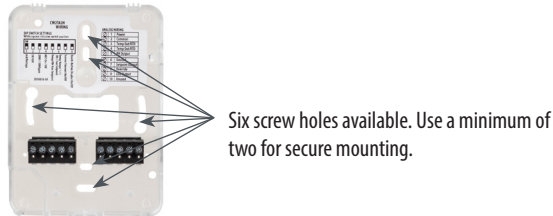

- Connect the wires to the screw terminals. Do not over-tighten the screws.

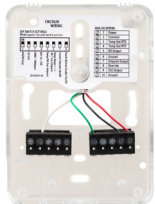

Wiring for models with temperature transmitter..

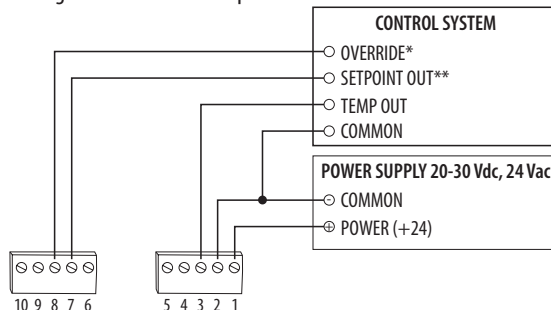

\* Momentary to ground.

\*\* 0-10V DIP switch selectable for temperature, RH or fan speed (off, 0V, Low 3.3V, Medium 6.7V or high 10V).

## Installation (cont.)

Wiring for models with RTD/thermistor:

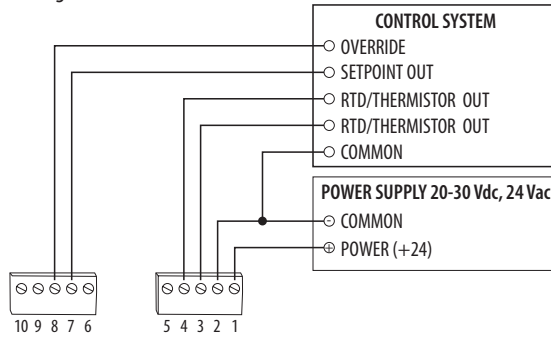

\* Momentary to ground.

\*\* 0-10V DIP switch selectable for temperature, RH or fan speed (off, 0V, Low 3.3V, Medium 6.7V or high 10V).

6. Set the DIP switches.

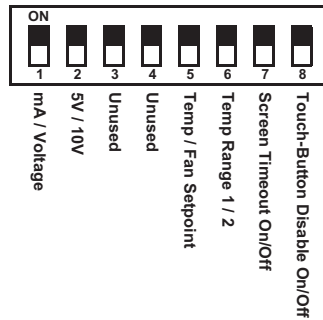

Switch	Function	Description
1	Output mode	ON - 4-20mA output mode enabled OFF - Voltage output mode enabled
2	Voltage output range*	ON - 0-5V output range enabled OFF 0-10V output range enabled
3	Unused	Unused
4	Unused	Unused
5	Setpoint output type	ON - Temperature setpoint enabled (temp range selected on DIP switch 6) OFF - Fan Speed setpoint enabled
6	Setpoint output temperature range	Temperature setpoint (must be enabled on DIP switch 5) ON - Temp range 1, 50 to 95 °F (10 to 35 °C) enabled OFF - Temp range 2, 32 to 122 °F (0 to 50 °C) enabled
7	Display times out and turns off after 6-10 seconds of touchscreen/button press	ON - Display Timeout enabled OFF - Display Timeout disabled
8	Touchscreen touch functions and buttons are disabled	ON - Touchscreen touch/button functions disabled OFF - Touchscreen touch/button functions enabled

\* Only used with voltage output mode enabled.

## Installation (cont.)

- With sensor base fully installed, align top of cover to mounting tabs on top of sensor base. Swing cover downward until it latches at the bottom.



- Install locking screw to secure cover in closed position.



## Touchscreen Operation

### Main Screen

The touchscreen user interface displays temperature sensor output values, setpoint value and menu button.

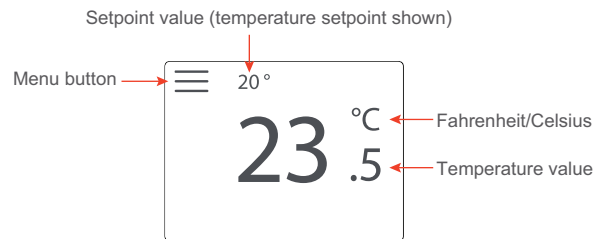

### Menu Screen

The menu screen opens when pressing the Menu button on the main screen. Integrator's submenu, occupancy/override, Fahrenheit/Celsius, settings and setpoint submenu (temp or fan, determined by DIP switch settings) are displayed on the menu screen.

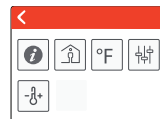

Temperature setpoint  
DIP switch selected

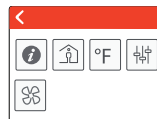

Fan speed setpoint  
DIP switch selected

## Touchscreen Operation (cont.)

### Menu Button Functions

 **Integrator's Submenu**  
Press this icon to access the Integrator's menu.

Submenu Only

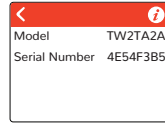



 **Occupied Override Button**  
Press this icon to provide momentary ground output to the controller

Single Press Only

 Signals occupied/override call to controller.

 **Fahrenheit/Celsius Switch**  
Press this icon to display either °C or °F.

Single Press Only

 Changes units to Fahrenheit when pressed.  
 Changes units to Celsius when pressed.

 **Settings**  
This icon provides the ability to change the color scheme of the display.

Submenu Only

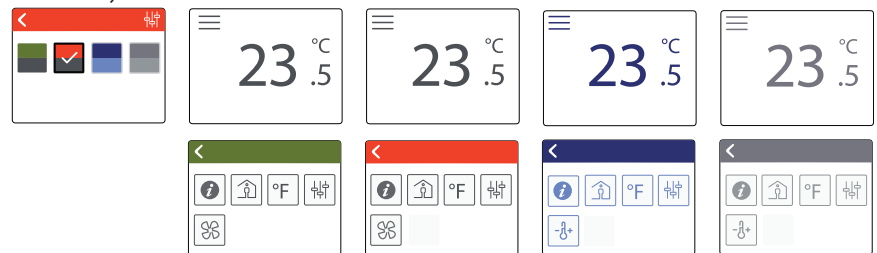

 **Temp Setpoint Adjustment**  
Click this icon to access the setpoint change menu. Mutually exclusive with fan speed, set by DIP switch.

Submenu Only

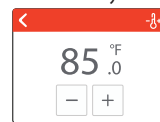

 **Fan Speed**  
Click this icon to access the fan speed menu. Mutually exclusive with humidity and fan speed. Set by DIP switch.

Submenu Only

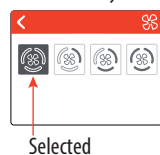

## LCD Display Operation *Button Functions*

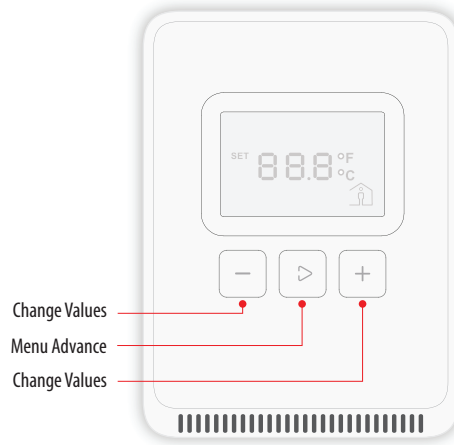

### *Display Icons*

The main screen displays sensor values for temperature and Celsius/Fahrenheit.

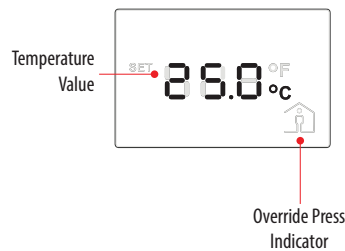

## Setpoint Function

A single 0-10V setpoint (temperature or fan speed) can be selected via DIP switch.

### *Temperature Setpoint Adjustment*

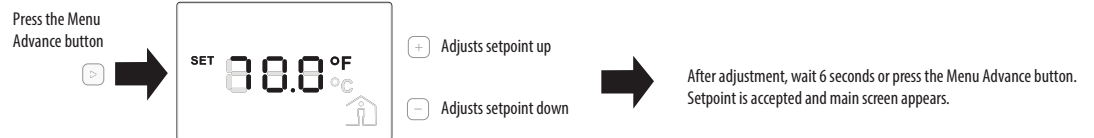

Note: Numeric information will flash while in Set mode.

### *Fan Speed Setpoint Adjustment*

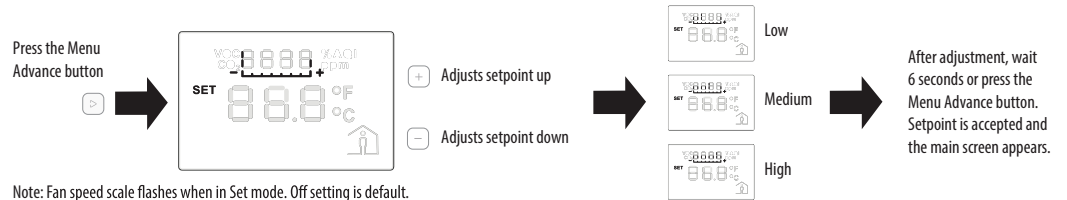

Note: Fan speed scale flashes when in Set mode. Off setting is default.

## Setpoint Function (cont.)

### Changing Celsius and Fahrenheit Scales

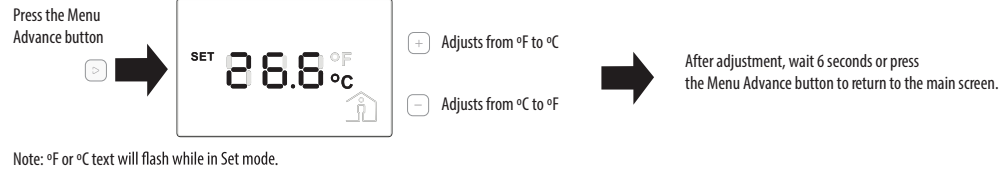

### Occupied/Override Button

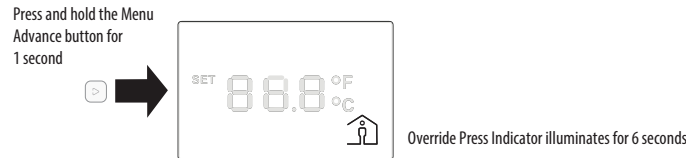

## China RoHS Compliance Information

### Environment-Friendly Use Period (EFUP) Table

部件名称	有害物质 - Hazardous Substances					
Part Name	铅 (Pb)	汞 (Hg)	镉 (Cd)	六价铬 (Cr (VI))	多溴联苯 (PBB)	多溴二苯醚 (PBDE)
电子件 Electronic	X	O	O	O	O	O

本表格依据SJ/T11364的规定编制。

O: 表示该有害物质在该部件所有均质材料中的含量均在GB/T 26572规定的限量要求以下。

X: 表示该有害物质至少在该部件的某一均质材料中的含量超出GB/T 26572规定的限量要求。

(企业可在此处，根据实际情况对上表中打“X”的技术原因进行进一步说明。)

This table is made according to SJ/T 11364.

O: indicates that the concentration of hazardous substance in all of the homogeneous materials for this part is below the limit as stipulated in GB/T 26572.

X: indicates that concentration of hazardous substance in at least one of the homogeneous materials used for this part is above the limit as stipulated in GB/T 26572

Z000057-0B