

# HD SERIES



# HD SERIES

## Digital RH and RH/T Transmitters

### Installer's Specifications

HS Element	Digitally profiled thin-film capacitive (32-bit mathematics) U.S. Patent No. 5,844,138
Accuracy @ 25°C*	±1%, ±2%, ±3%, or ±5% respectively @ 10 to 80% RH%; Multi-point calibration, NIST traceable
Reset Rate**	24 hours
Stability	±1% @ 20°C (68°F) annually, for two years
Hysteresis	1.5% typical
Linearity	Included in Accuracy spec.
Operating Humidity Range	0 to 100% RH
Operating Temperature Range	-40° to 50°C (-40° to 122°F)
Temperature Coefficient	+0.1% RH/°C above or below 25°C (typical)
Analogue Output	4-20mA version: 2-wire, polarity insensitive; 0-5V/0-10V versions: 3-wire, observe polarity
Scaling	0-100% RH
Input Power***	4-20mA version: loop powered 12-30VDC only, 30mA max.; 0-5V/0-10V versions: 12-30VDC/24VDC, 15mA max.
Optional Temperature Transmitter Output	Digital, 4-20mA or 0-5V/0-10V output; resolution/accuracy ±0.5°C (±1°F) typical
Conformance	EMC EN 50081-1, EN 50082-1, EN 61000-4-4, EN 61000-4-5, EN 61000-4-3, ENV 50204, EN 61000-4-6

\* Specified accuracy with 24VDC supplied power with rising humidity.  
\*\* Reset Rate is the time required to recover to 50% RH after exposure to 90% RH for 24 hours.

\*\*\* One side of transformer secondary is connected to signal common. Isolation transformer or dedicated power supply may be required.

RTD Thermistors are not compensated for internal heating of product  
To conform to EMC standards, shielded cabling and technical information is available from factory upon request or is available on our website: [www.veris.com](http://www.veris.com)

### QUICK INSTALL



Observe handling precautions for static sensitive devices to avoid damage to the circuitry which would not be covered under the factory warranty.

1. Choose a location on the return air duct.
2. Drill a 7/8" diameter hole for the sensor probe.
3. Mount junction box housing to duct using self-tapping screws (included).
4. Insert probe through black swage fitting into duct. Tighten swage fitting.
5. Wire probe (see Wiring section). Leave wires at factory length to allow for a service loop (to removed sensor from junction box for service without disturbing the conduit).

### DIMENSIONS

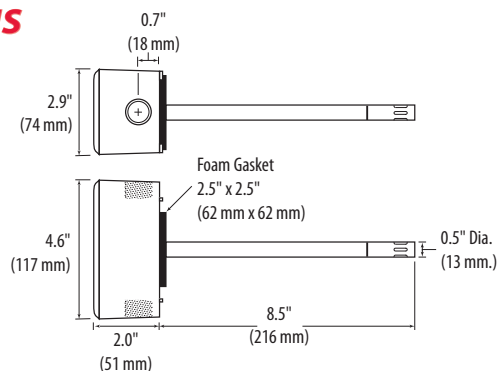

## NOTICE

- This product is not intended for life or safety applications.
- Do not install this product in hazardous or classified locations.
- Read and understand the instructions before installing this product.
- Turn off all power supplying equipment before working on it.
- The installer is responsible for conformance to all applicable codes.

### PRODUCT IDENTIFICATION

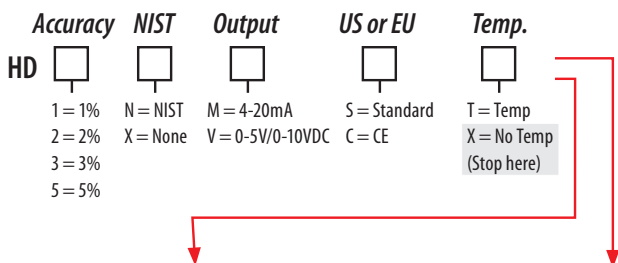

#### Humidity Transmitter Combination

<b>Sensor Type</b>	<b>Range</b>	<b>OPTION Temp Cert</b>
<input type="checkbox"/>	<input type="checkbox"/>	<input type="checkbox"/>
= Transmitter	1 = -40° to 50°C (-40° to 122°F) 2 = 0° to 50°C (32° to 122°F)	Blank = None 1 = 1pt Cal 2 = 2pt Cal

#### Humidity RTD/Thermistor Combination

<b>Sensor Type</b>	<b>OPTION Temp Cert</b>
<input type="checkbox"/>	<input type="checkbox"/>
B = 100R Platinum, RTD C = 1k Platinum, RTD D = 10k T2, Thermistor E = 2.2k, Thermistor F = 3k, Thermistor G = 10k CPC, Thermistor H = 10k T3, Thermistor J = 10k Dale, Thermistor K = 10k with 11k shunt, Thermistor M = 20k NTC, Thermistor N = 1800 ohm TAC, Thermistor Q = 1uA/°C, Linitemp R = 10k US, Thermistor S = 10k 3A 221, Thermistor T = 100k, Thermistor U = 20k "D", Thermistor	Blank = None 1 = 1pt Cal 2 = 2pt Cal

**OPERATION**

The HD Series duct-mounted humidity sensors provide high accuracy humidity monitoring with a fully replaceable HS element for easy field maintenance. NIST certified accuracy and temperature sensing capability are available.

**TROUBLESHOOTING**

Problem	Solution
Filter tip does not fit on probe	HS element is backwards; reverse element.
Unit reads approx. 4.5mA	HS element is backwards; reverse element.
Unit reads 100% with new replacement sensor	Unit must be unpowered when installing a new sensor; interrupt sensor power to restart.
Accuracy appears incorrect	<ul style="list-style-type: none"> <li>Remove HS element while powered and verify output goes to full scale.</li> <li>Verify voltage test leads on 4-20mA models corresponds to the 4-20mA output.</li> </ul>

**WIRING**

*HD, 0-5V/0-10V Versions*

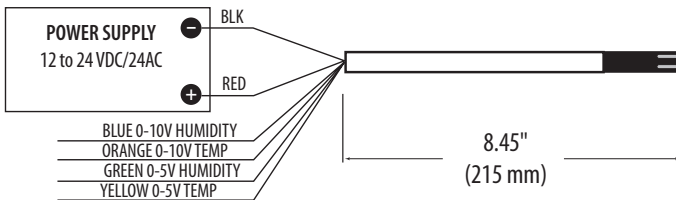

*HD with RTD/Thermistor, 0-5V/0-10V Versions*

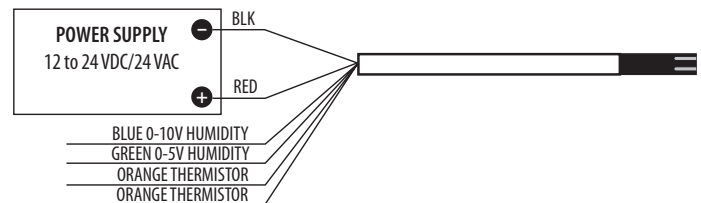

*NOTE: For 24 VAC transformer powered applications, one side of transformer secondary is connected to common. Isolation transformer or dedicated power supply may be required.*

*HD, 4-20mA Versions*

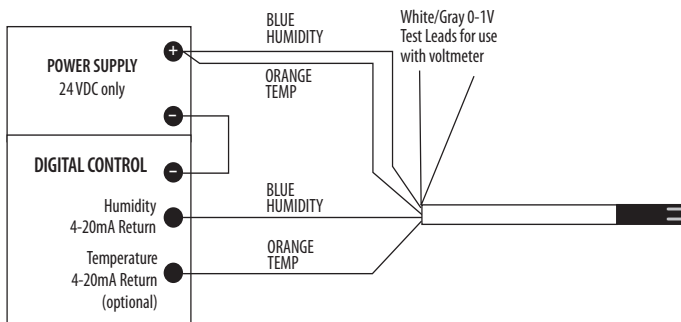

*HD with RTD/Thermistor, 4-20mA Versions*

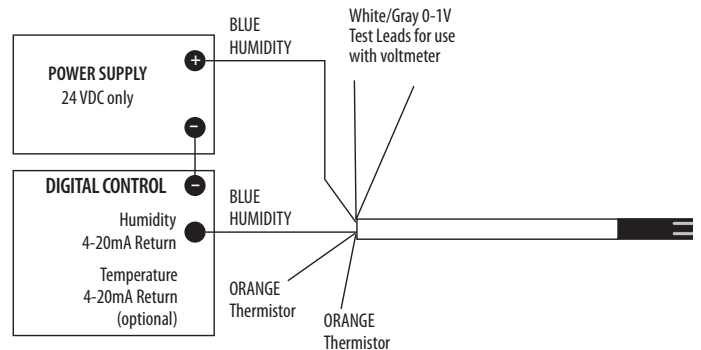

**TEST POINTS AND SETUP VERIFICATION**

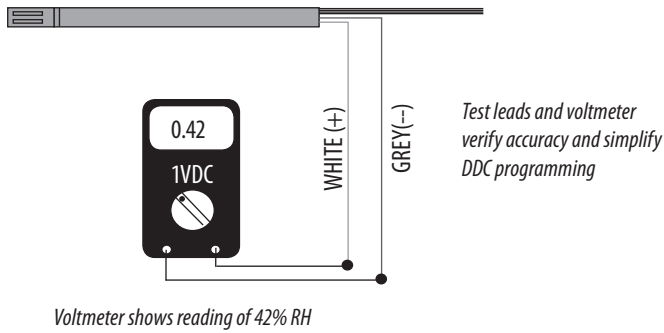

For 4–20 mA versions: Test leads output 0-1VDC corresponding to 0 to 100% RH sensor reading. For example, a 0.42 VDC output on test points equals 42% RH sensor reading. These test points also provide an output that verifies mother board accuracy when the HS element is removed. CONNECT TEST POINT LEADS TO VOLTMETER ONLY. This output is not suitable for connection to a DDC panel.

To check motherboard functionality using the test leads, remove sensor element. 1.0 VDC reading verifies motherboard functionality.

To verify sensor accuracy, de-power unit and insert a replacement HS element. Repower unit and compare readings to original sensor. For example, if test points read 0.40VDC (40% RH) with original sensor, and 0.45VDC (45% RH) with new replacement sensor, the original sensor is 5% off specification. This method of ensuring accuracy offers more precision than using slings or other devices, and it eliminates the need to manually adjust sensors to an unstable standard.

Note: Temperature, body sweat, and breath effect humidity. Ensure that conditions are stable to evaluate performance.

Filter may be washed using warm water and soft brush. Do not attempt to scrub HS element.

For 0-5V/0-10V versions, use output as test point and scale accordingly.

**CALIBRATION-FREE SENSOR**

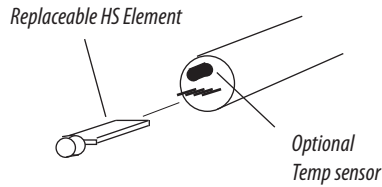

The microprocessor-profiled capacitive HS element can be replaced in the field without calibration.



Observe handling precautions for static sensitive devices to avoid damage to the circuitry which would not be covered under the factory warranty.

**To replace HS Element**

1. Disconnect power to the unit.
2. Remove probe from junction box by loosening black swage nut and sliding out.
3. Removed HS element by unscrewing probe filter tip and gently pulling sensor board from jack. Do not attempt to remove black temperature sensor next to board.
4. Install new HS element, observing orientation such that filter tip can be reinstalled.

**Replacement HS Element Ordering Information**

HS2xxx	Replacement 2% HS Element, Duct
HS3xxx	Replacement 3% HS Element, Duct
HS4xxx	Replacement 5% HS Element, Duct
HS1Nx	Replacement 1% HS NIST Element, Duct
HS2Nx	Replacement 2% HS NIST Element, Duct

Replacement filters are provided with all elements. Order appropriate element accuracy to match motherboard accuracy for compatability.